



Installation Guide of Billizone

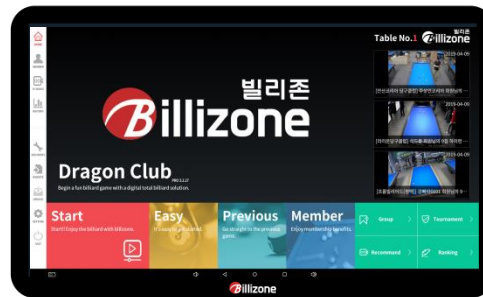

Table of Contents

Ready to Install?

Quick Start

Hardware Installation

- Scoreboard and Camera Installation
- Cabling
- Network Installation : Android Setting

Setup Router(AP)

Setup IP Camera



To install Billizone properly, you need to have below information.

	Data	Remarks
Club ID		
Password of cameras		
DDNS Domain		
Password of the DDNS Domain		



If you don't have above information yet, please send below information to 'torilab.ryu@gmail.com by email' or call to +82-70-4009-8061.

	Data	Remarks
Club Name		
Club Address		
Club Phone Number		
Internet Address (WLAN)		
About Installation details		

Tablet & Devices

BZ Pro Score

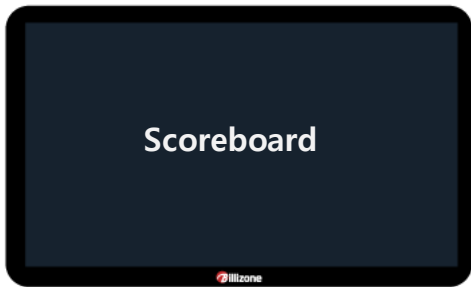

BZ Pro Vision
BZ AIR

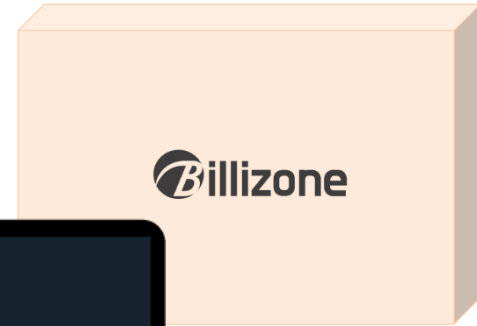
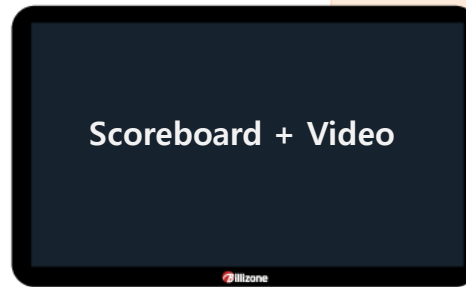

Power Adapter & Cable



Ethernet Cable Cat.6
(Optional)



Router(BillizoneAP)
(Optional)



IP Camera
(BZ Pro-Vision)



IP Camera
(BZ AIR)



PoE Device
(BZ Pro-Vision, AIR)

(*) The real delivered devices could be different to above picture according to install configuration.

Step 1. Power On

Step 2. Configuring the network

Step 3. Configuring the Club information

Step 4. Setting Scoreboard Configuration

Step 5. Update Billizone Software to the latest version

Step 6. Begin to run Billizone

Step 1. Power On

The tablet is started automatically as you connect the power code.
You can use '*Power Switch*' for turning on & off the tablet power.



- The display after booting.

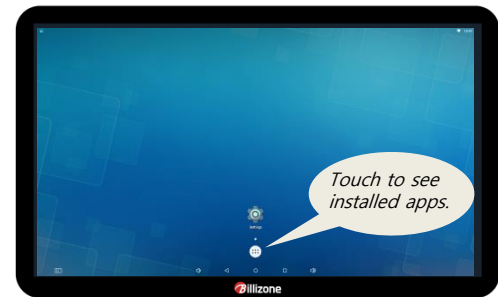

- Find app 'BZ Station 22' among installed apps.

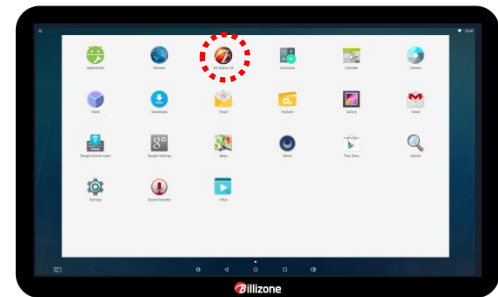

(*) If you use 110V then you need a plug-in accessory for converting to 110V

Step 2. Configuring the network

You need to check if the internet is connected by Wi-Fi or Wire(Ethernet).

If you use 'BZ Pro Score', you can use 'Wi-Fi' connection. - *Refer to 'Network Installation' for detail information.*

If you use 'BZ Pro Vision', we recommend to use Wire(Ethernet) connection for all devices.

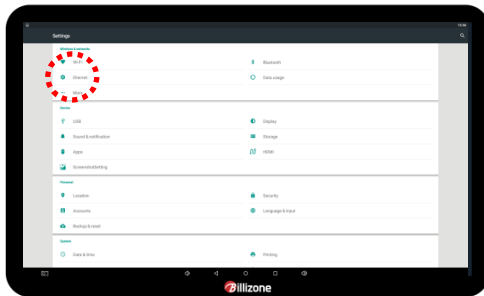

- 'Wi-Fi'

Select the proper Router

If you use 'BZ Pro Score' with 'BZ Pro Account' then you should find the designated Router which is defined on 'Network on Scoreboard configuration'

If you use only one or sum number of 'BZ Pro Score' then you can use any Wi-Fi connection.

(You cannot use both Wi-Fi and Ethernet together.*

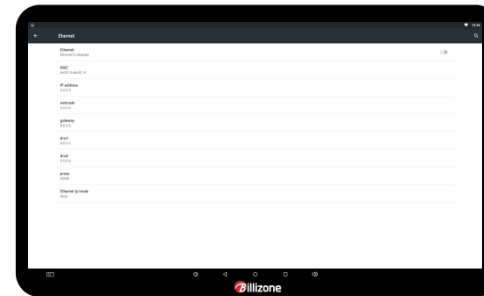

- 'Ethernet'

The IP address is defined according to table number and camera .

Refer to 'Network Installation' for detail information.

Step 3. Configuring the Club information

After enabling the network connection, you can register your billizone system to Billizone Center.

- Start 'BZ station 22'

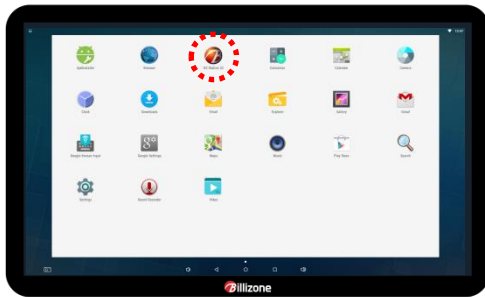

Ethernet

- Billizone Authentication

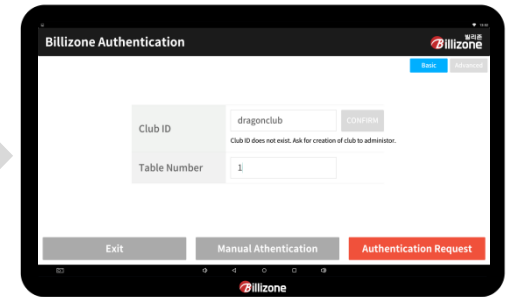
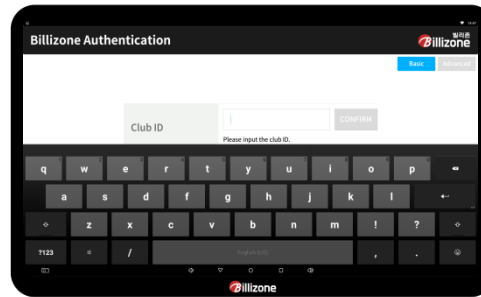

- Enter the 'Club ID' which is delivered to you then touch 'CONFIRM' button
- Enter the billiard table number for this tablet working
- Touch 'Authentication Request'



Club ID is predefined by Billizone Center, so you need it before trying to register. If you don't have it, contact our local sales partner or send an email to torilab.ryu@gmail.com

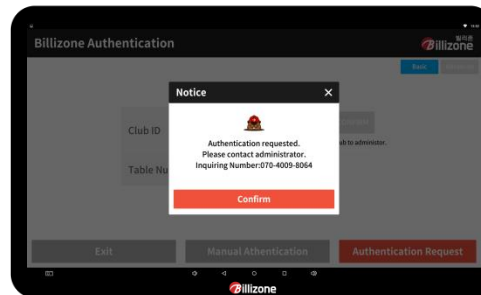

- Touch 'Confirm'

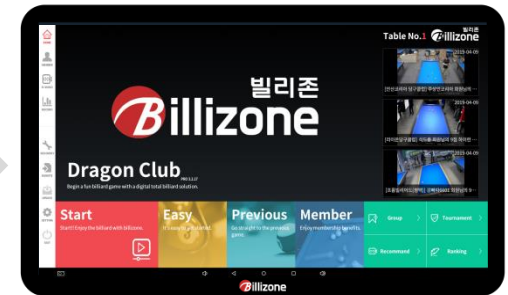

- Billizone is restarted if authentication process has been succeeded.

Step 4. Setting Scoreboard Configuration

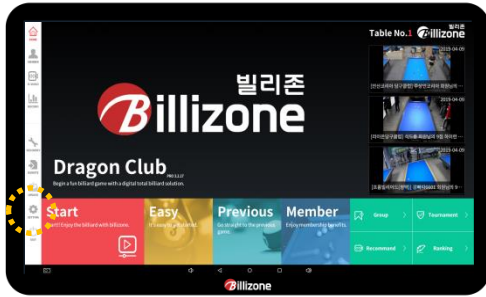

- Touch 'Setting'



- Enter the initial password : 123654789

• SYSTEM

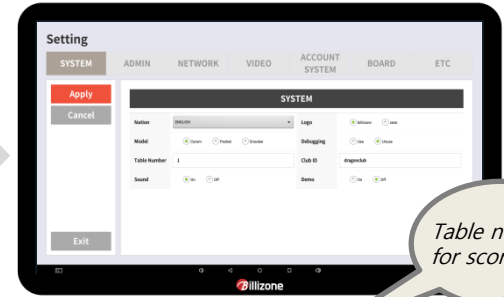

- ✓ Table Number: **1**
- ✓ Club ID: *dragonclub*

Table number for scoreboard

Registered at authentication step.

• ADMIN

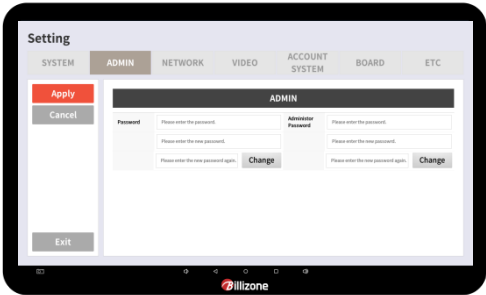

✓ Password

- Change the password to what you want to use

• NETWORK

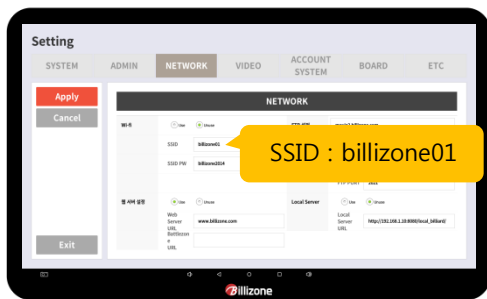

✓ Wi-Fi

- If you choose 'Use' then Billizone try to connect router defined SSID and PW.
- **If you want to use any Wi-Fi router select 'Unuse' option.**



Please change the password by new one. You should keep this new password safely.



If you choose 'outside01' router at 'step 2, Wi-Fi' and configure the 'Wi-Fi Use' of 'billizone01', it cause unstable connection. The Wi-Fi is connected and disconnected Repeatedly.

Step 4. Setting Scoreboard Configuration - continued

- VIDEO : 'only for 'BZ Pro Video'

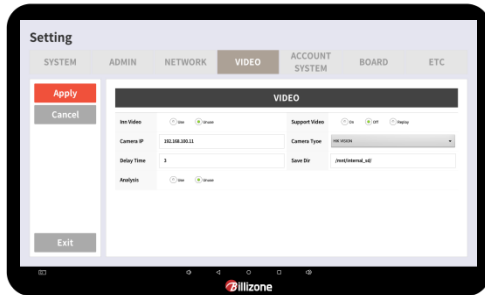

✓ Inn Video

- 'Use' : Extract Inning Video during the game
- 'Unuse' : No inning video

✓ Support Video

- 'On' : Install IP camera for this table
- 'Off' : Install 'BZ Pro Score'

✓ Camera IP

- 192.168.100.11
 - {Table# 1 & Camera# 1}
 - {Local network area}

- ACCOUNT SYSTEM

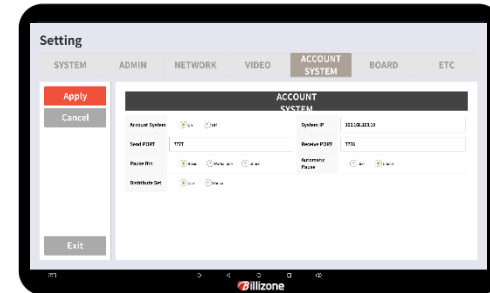

✓ Account System

- 'On' : Use 'BZ Pro PoS' in the network together.
- 'Off' : Not use 'BZ Pro PoS'

✓ System IP

- 192.168.100.10 : Set the IP address of 'BZ Pro PoS'



- ✓ We recommend to use xx.xx.100.10 for BZ Pro PoS.
- ✓ If IP is not same with 'BZ Pro PoS' then the PoS cannot communicate with scoreboard

Step 4. Setting Scoreboard Configuration - continued

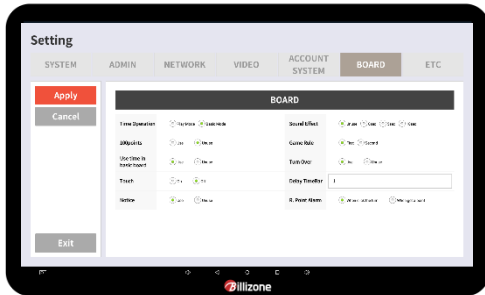

✓ Time Operation

- Play Mode: Controlled by Operator(ex: Referee)
- Basic Mode: Automatically started after turning over or getting point.

✓ Sound Effect

- 'Unuse' : Not Use
- '5 Sec' : Alarm when 5 seconds remaining

✓ Game Rule

- First: Game over if anyone gets the target points
- Second: Game over after second player's trial

❖ R. Point Alarm : Remaining Points

- When Click the turn
- When Get a score

• ETC

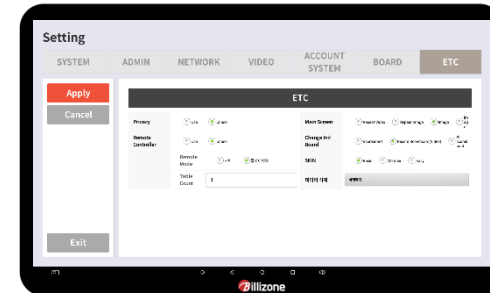

✓ Main Screen

- 'Repeat Video': play the video
- 'Repeat Image': display some images
- 'image': display an image

✓ Change Init Board

- 'Scoreboard':
- 'Record Scoreboard':



You should touch 'Apply' at each step to save the change then move to another step.

Step 5. Update Billizone Software to the latest version

It is automatically check the latest version then update if the new version is released.

✓ *By using "UPDATE"*

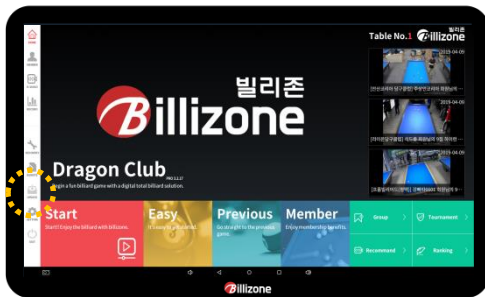

- Touch 'UPDATE'

or

✓ *By Rebooting the tablet*

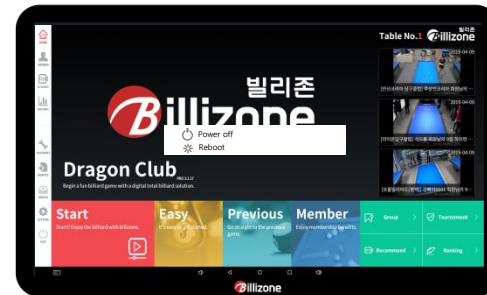

- Pressing 'Power Switch'

< Side View >



Pressing
2~3 seconds



- ✓ You can screen off/on by pressing 'Power Switch' lightly.
- ✓ It is recommended to power off the tablet by a day for operating optimal status.

Step 6. Begin to run Billizone

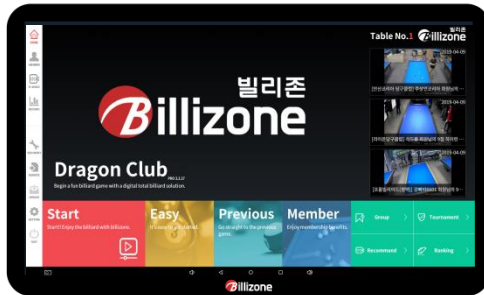

Become a Billizone member

- Select Scoreboard for your game



member game

Guest Game

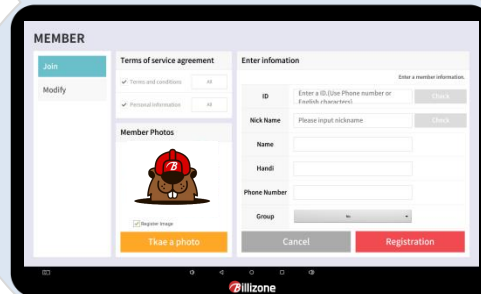

- ✓ Billizone ID and nickname is a unique in worldwide, you can enjoy your game at any billiard club with billizone.
- ✓ Client(player) can see his all game data at billizone app by login his ID.

- **Scoreboard and Camera Installation**
- **Cabling**
- **Network Installation : Android Setting**

Scoreboard and Camera Installation

Camera is located as below picture.

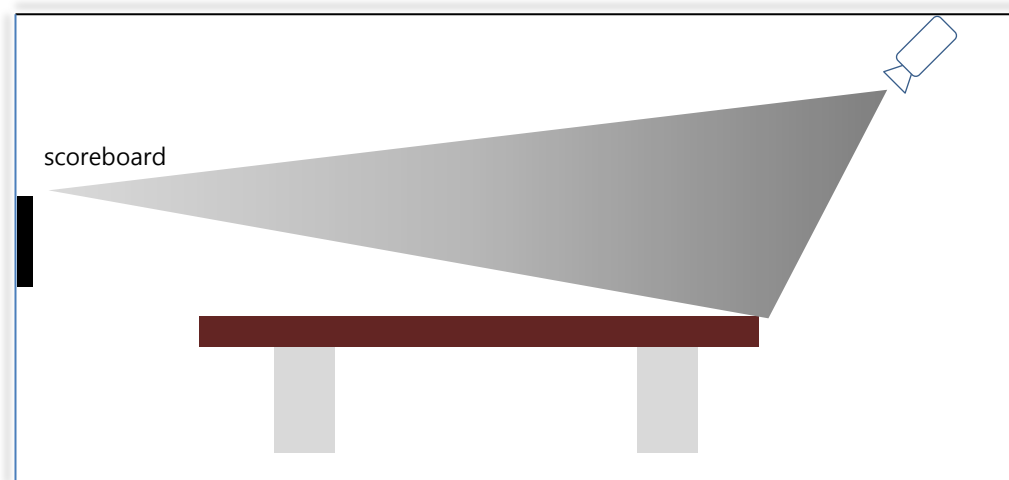

Hardware Installation

Billizone Pro V (Side Cam)



Hardware Installation

Scoreboard and Camera Installation

Camera is located at upper center of table.

Billizone AIR
Billizone Pro V (Upper Cam)

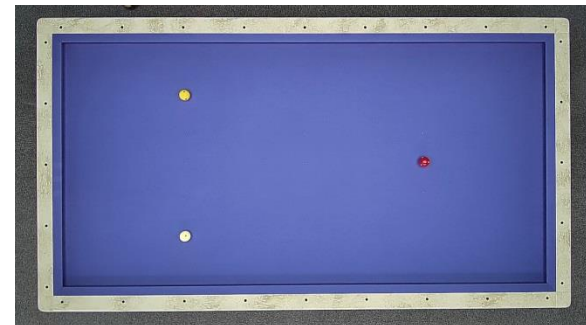
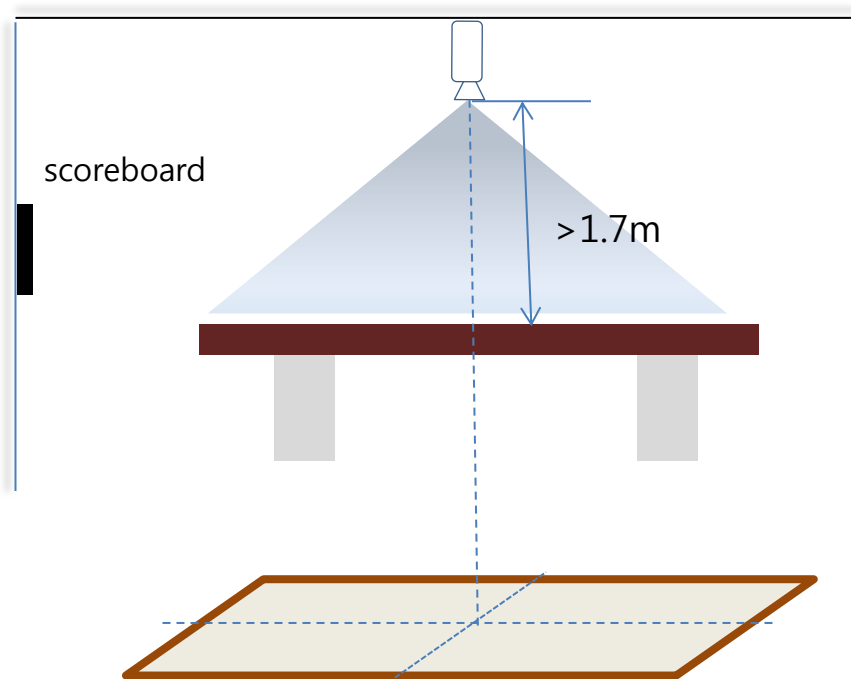

Cabling

Hardware Installation

Billizone Pro V (Side Cam)

Scoreboard and AP(Router) delivered to billiards club with proper configuration for installation.

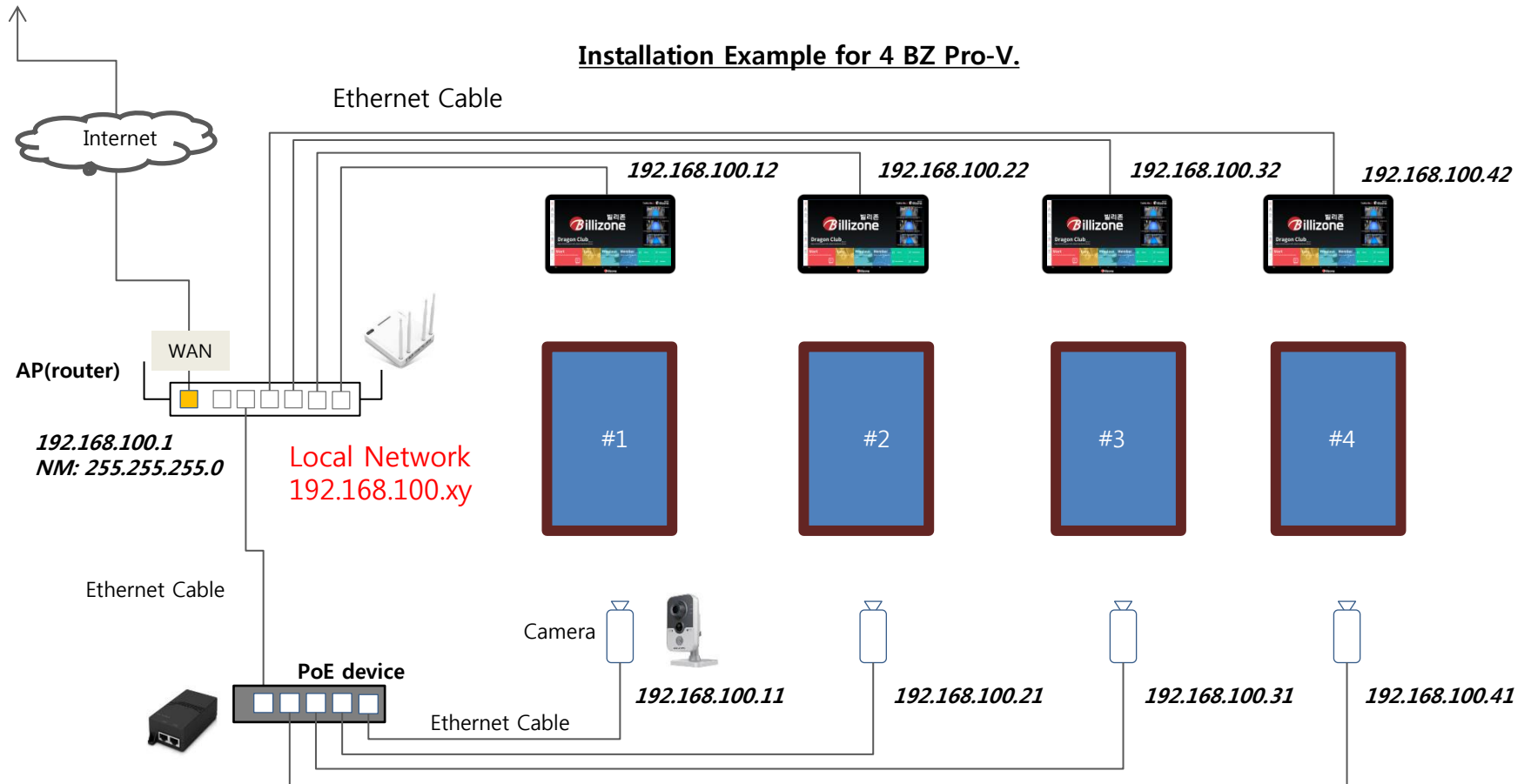

(*) If you install only scoreboard, BZ Pro-S, you can use Wi-Fi instead of cabling.

Cabling

Hardware Installation

Billizone Pro V (Upper Cam)

Scoreboard and AP(Router) delivered to billiards club with proper configuration for installation.

Installation Example for 4 BZ Pro-V : **Upper Cam on table #3**

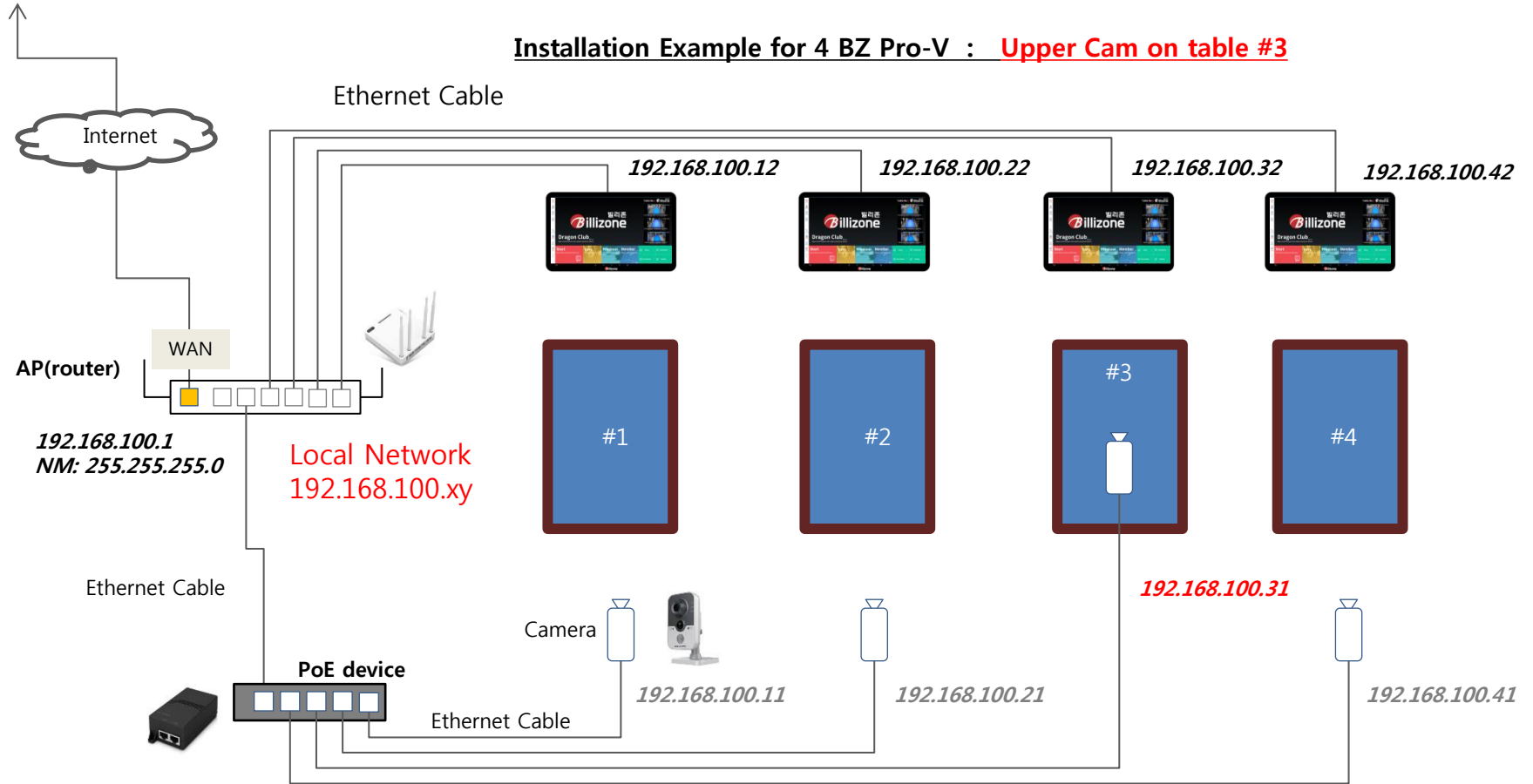

(*) If you install only scoreboard, BZ Pro-S, you can use Wi-Fi instead of cabling.

Scoreboard and Camera Installation

Camera is located at upper center of table.

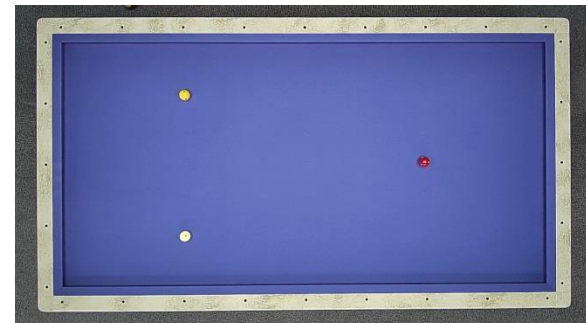
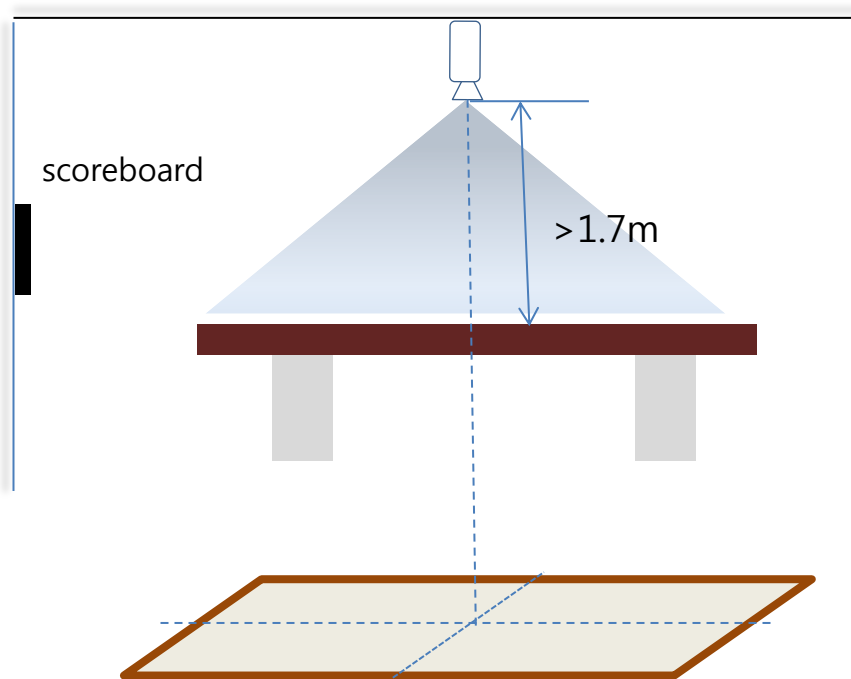

Cabling

Hardware Installation

Billizone AIR

Scoreboard and AP(Router) delivered to billiards club with proper configuration for installation.

Installation Example for 4 BZ AIR :

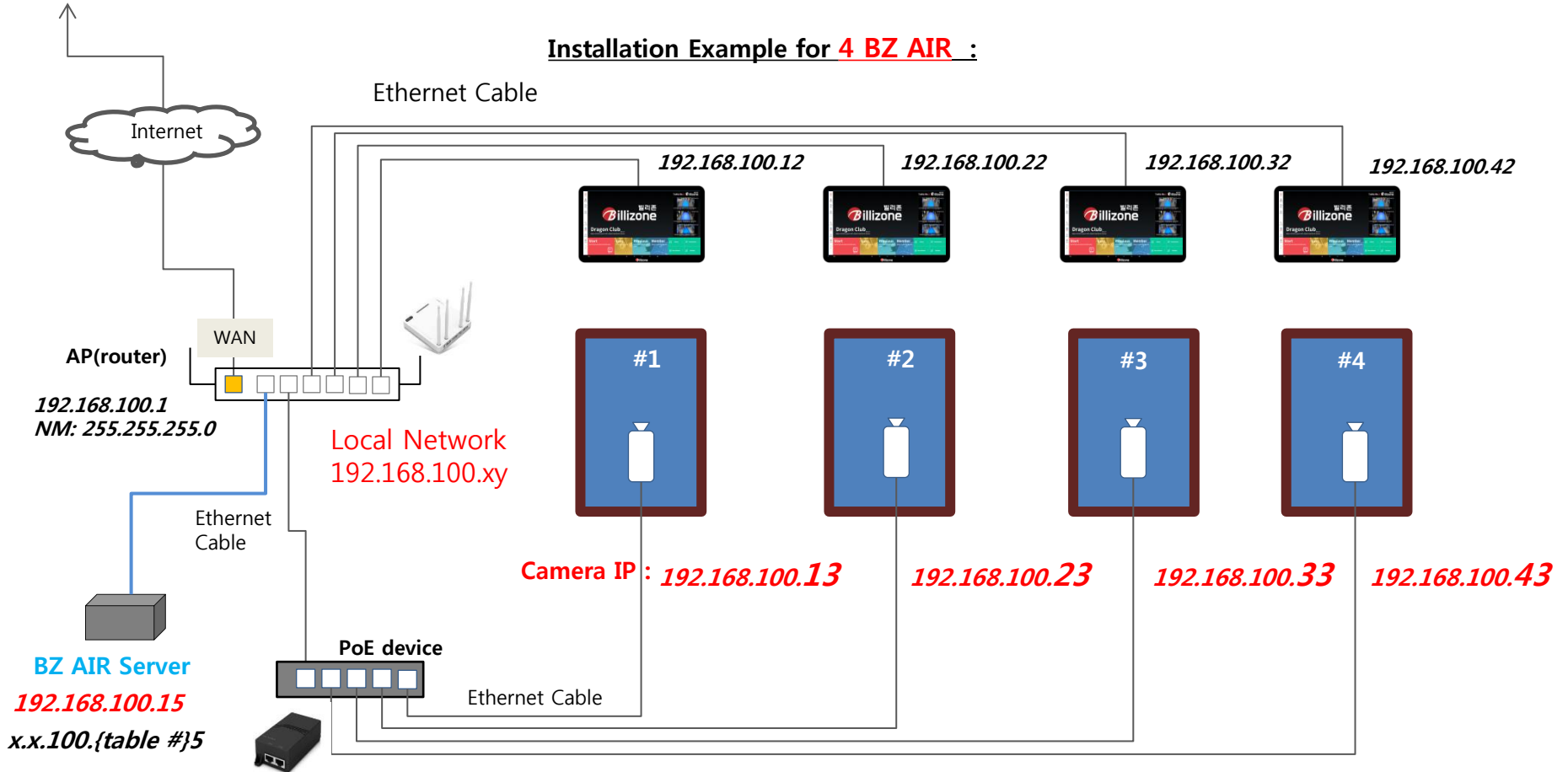

Attention : BZ AIR Server can be changed according to how many table need to be supported.
If you install 1 big server for some tablets, then the IP address of server should be x.x.x.15

Network Installation : Android Setting

- **Wireless & networks :**

Case 1) Wi-Fi Enable : Install for BZ Pro-S (Scoreboard) only

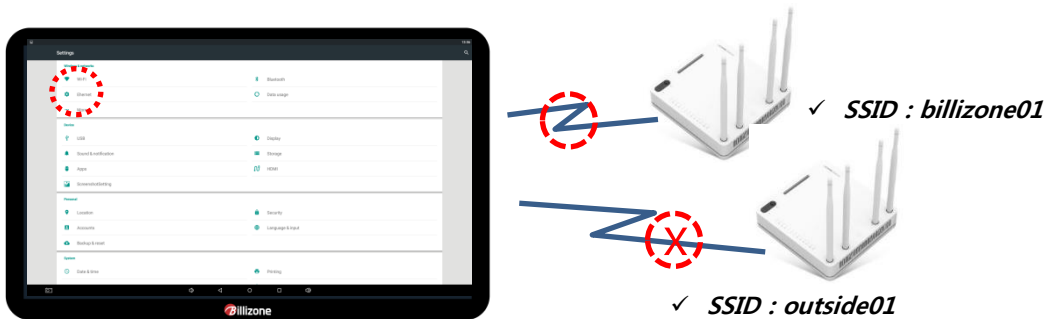

[A] You can use any Wi-Fi router if

- you install only some number of 'BZ Pro Score'

[B] But if you install 'BZ Pro PoS' together

- You have to use router defined on 'Scoreboard Setting-Network'
- Connect to Router of 'billizone01' among many WI-Fi routers

** If you choose 'Wi-Fi Use' option and defined the SSID.*

Quick Start

Step 4. Setting Scoreboard Configuration

- NETWORK



✓ Wi-Fi

- **For [B],** If you choose 'Use' then Billizone try to connect router defined SSID and PW.
- **For [A],** 'Unuse' means that you can connect any Wi-Fi routers.

Network Installation : Android Setting

- *Wireless & networks :*

Case 2) Ethernet : Recommend when BZ Pro-V or BZ Pro PoS installation

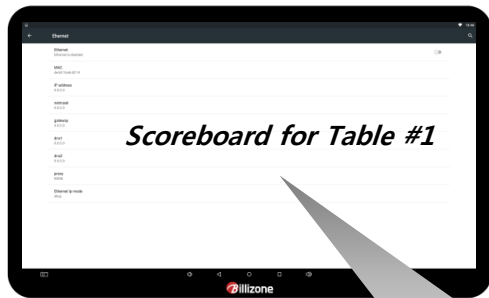

Camera for Table #1



- ✓ You can use local network as
192.168.200.xy or 192.168.10.xy
x : table number
y : 1 for tablet, 2 for camera

Local Network
192.168.100.xy



Router (gateway)
: 192.168.100.1

	Table #1	Camera #1 (Side)	Camera #1 (Upper)	BZ AIR Server	Table #2	Camera #2 (Side)
IP address	192.168.100.1 2	192.168.100.1 1	192.168.100.1 3	192.168.100.1 5	192.168.100.22	192.16.100.21
Netmask	255.255.255.0	255.255.255.0	255.255.255.0	255.255.255.0	255.255.255.0	255.255.255.0
gateway	192.168.100.1	192.168.100.1	192.168.100.1	192.168.100.1	192.168.100.1	192.168.100.1
dns1						
Ethernet IP mode	static	static	static	static	static	static

(* Other configurations are configured at factory



Enjoy Billiards @ Billizone !!!

Download billizone app.

Welcome your any comments
Email: billizone@gmail.com
